

INDUCTANCE	LOSSES	WEIGHT
0.055 mH	110 Watts	80 Lbs

NO.	CHANGE DESCRIPTION	BY	DATE	C'K'D
02	REVISED PER ECR 7175, ADDED CD	RS	8/24/10	

FILE:

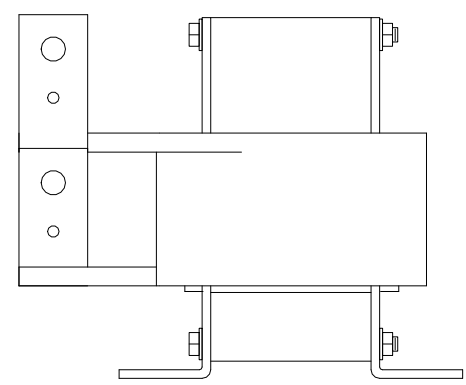
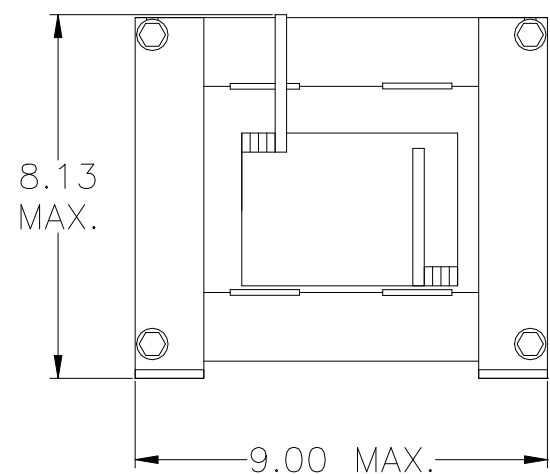
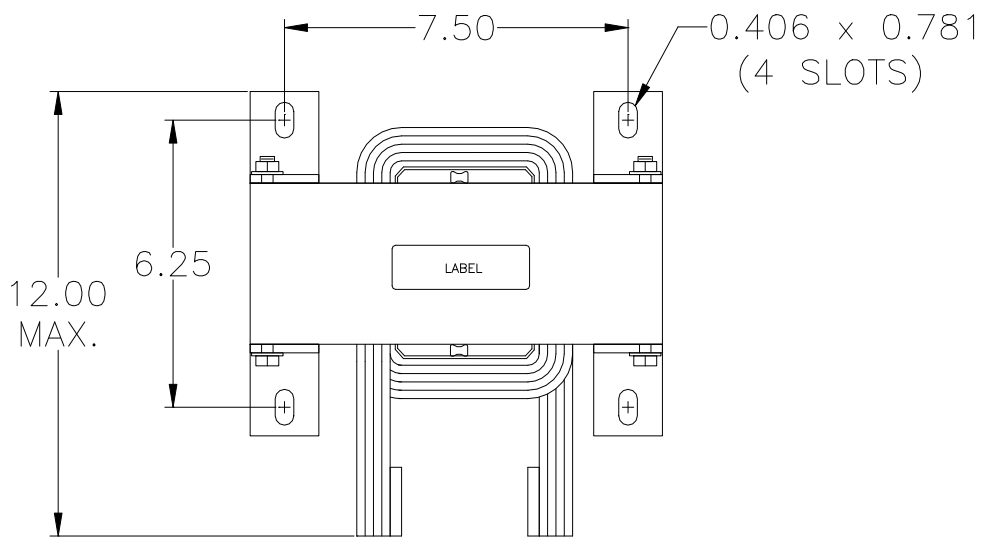

UNLESS OTHERWISE SPECIFIED, DIMENSIONS ARE IN INCHES [mm] AND TOLERANCES ARE:

DECI. FRAC.

ANGLES DRILLED HOLES

PART NAME:	DC LINK CHOKE
DESCRIPTION:	OUTLINE DIMENSION
FINISH:	

MTE CORPORATION MENOMONEE FALLS, WISCONSIN			
CD 450RB001			REV. 02
SCALE	NTS	DATE 06/09/04	C'K'D
REF.	DR. BY	KPH	APP'D